

1500W 7 FIN BLACK OIL FILLED RADIATOR

2500108 - Instruction Manual

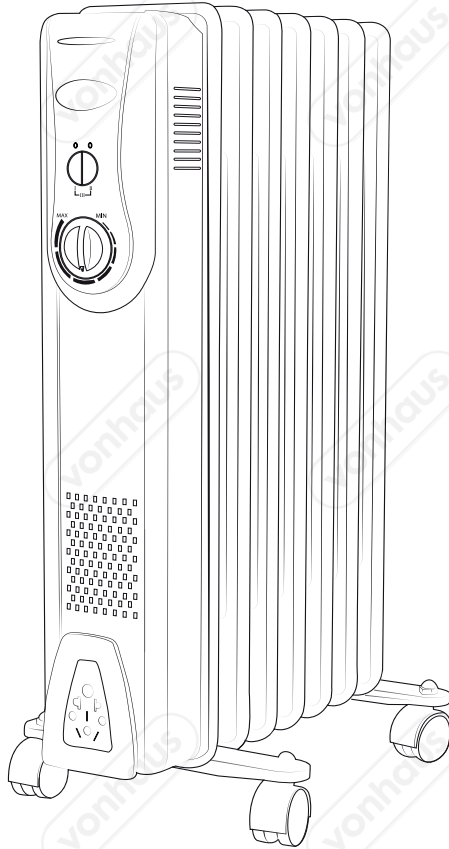

THIS PRODUCT IS ONLY SUITABLE FOR WELL INSULATED SPACES OR OCCASIONAL USE.

CONTENTS

Safety Instructions

1

Safety Instructions, Safety Symbols

2

Specification

3

Information Requirements for Electric Local Space Heater

4

Base Assembly, Safety Features

5

Operation, Cleaning & Care

6

Troubleshooting

7

User Notes

8

Warranty

9

WARNING

PLEASE READ THESE INSTRUCTIONS CAREFULLY AND KEEP FOR FUTURE REFERENCE

INTENDED USE.

This 1500W Oil Filled Radiator is designed for light domestic use only. It is not intended for heavy duty, commercial or industrial use, and is not suitable for use outdoors.

WARNING! Do not use this appliance to dry clothes.

This appliance cannot be used by children or persons with reduced physical, sensory or mental capabilities or lack of experience and knowledge if they have not been given supervision or instruction concerning use of the appliance in a safe way and understand the hazards involved. Children shall not play with the appliance. Cleaning and user maintenance shall not be made by children without supervision.

WARNING! This product is not suitable to be used on long pile carpets.

Use this appliance only as described in this manual. Any other use is not recommended by the manufacturer and may cause fire, electric shock or injury.

PRIOR TO USE.

Remove the packaging and make sure that the appliance is intact. If in doubt, do not use the appliance and contact DOMU Brands Customer Services.

Do not leave packaging materials such as bags and staples within reach of children. Dispose of packaging carefully and with consideration for the environment.

It is recommended that you retain the appliance box for seasonal storage.

For your convenience, record the date you received the appliance on the 'Warranty' page of these instructions and attach your proof of purchase. Retain this information in the event that a warranty service is required.

SAFETY INFORMATION.

When using any electrically-powered appliance, basic safety precautions should always be followed to reduce the risk of

fire, electrical shock, or injury to persons or property.

CABLES AND PLUGS.

Check to ensure your electricity supply matches that shown on the rating label of the appliance. The appliance must only be used as rated.

Do not operate any appliance with a damaged cord or plug, or after the appliance malfunctions or has been dropped or damaged in any manner. Take to a qualified electrical person for service and repair.

Do not connect the appliance to the mains voltage until completely assembled and adjusted.

Unroll the cord before operating.

Operating with a coiled cord may cause overheating and risk of fire.

The use of an extension cord with this appliance is not recommended.

Do not allow the cord to come into contact with the appliance surface during operation.

Do not run the cord under carpeting, mats or rugs etc. Arrange the cord away from traffic areas so that it will not be tripped over.

Do not twist, kink or wrap the cord around the appliance as this may cause the insulation to weaken and split.

Always unplug the appliance when not in use. Do not leave unattended.

Always switch off the appliance before unplugging from the power socket.

Always hold the plug when removing it from the wall, do not pull the cord.

CAUTION: In order to avoid a hazard due to inadvertent resetting of the thermal cut-out, this appliance must not be supplied through an external switching device, such as a timer, or connected to a circuit that is regularly switched on and off.

⚠️ WARNING ⚠️

PLEASE READ THESE INSTRUCTIONS CAREFULLY AND KEEP FOR FUTURE REFERENCE

RISK OF PERSONAL INJURY.

Use this appliance only as described in this manual.

Do not use this appliance with any type of external timer.

Always operate upright, on a flat surface only.

This appliance heats up when in use. To avoid burns, do not touch the front of the appliance or any of the grilles or vents.

WARNING! DO NOT COVER.

Do not cover in any manner as the appliance may overheat and become a fire risk.

Keep all objects at least 1 metre from the front, side and rear of the appliance.

Do not operate the appliance with wet hands.

Do not immerse in liquid or use the appliance near water as this could create an electrical shock hazard.

If the appliance accidentally comes into contact with water, switch off the power supply and do not touch the appliance. Never attempt to remove the cover of the appliance. Repairs requiring opening the appliance or access to internal parts must be carried out by a qualified electrician or repair service professional. There are no user-serviceable parts of this appliance (excluding the plug fuse).

Before moving the appliance, switch it

off by unplugging it from the wall and allowing it to cool.

POSITIONING YOUR RADIATOR.

This appliance is designed to be placed on a hard, level surface. When positioning, please keep the following points in mind:

Do not locate in areas of high foot traffic.

To avoid accidents, always ensure that the power cord and appliance are in full view.

Do not fit the appliance in confined spaces such as cupboards or wardrobes.

Do not operate the appliance in areas where gasoline, paint or other flammable liquids are used or stored.

Do not operate the appliance in bathrooms, laundry areas or similar moist indoor locations. Do not use in the immediate surroundings of a bath, shower or swimming pool.

The appliance must not be located immediately below or in front of a socket outlet.

The socket must always be accessible in order to disconnect the appliance from the electrical supply for maintenance.

Store the Radiator carefully in a dust-free area during the off season.

It is ideal to store the Radiator in the box in which it was supplied.

Neatly wind the cord of the Radiator to prevent damage.

SAFETY SYMBOLS

Please ensure you understand their meanings before operating this product in order to prevent personal injury and avoid damage to the appliance.



WARNING!

Pay attention to all safety and guidance



Read manual before use



WARNING!

Do not cover

PRODUCT SPECIFICATION

**RATED
VOLTAGE**

V

220-240V ~50Hz

**RATED
POWER**

W

1000/2000

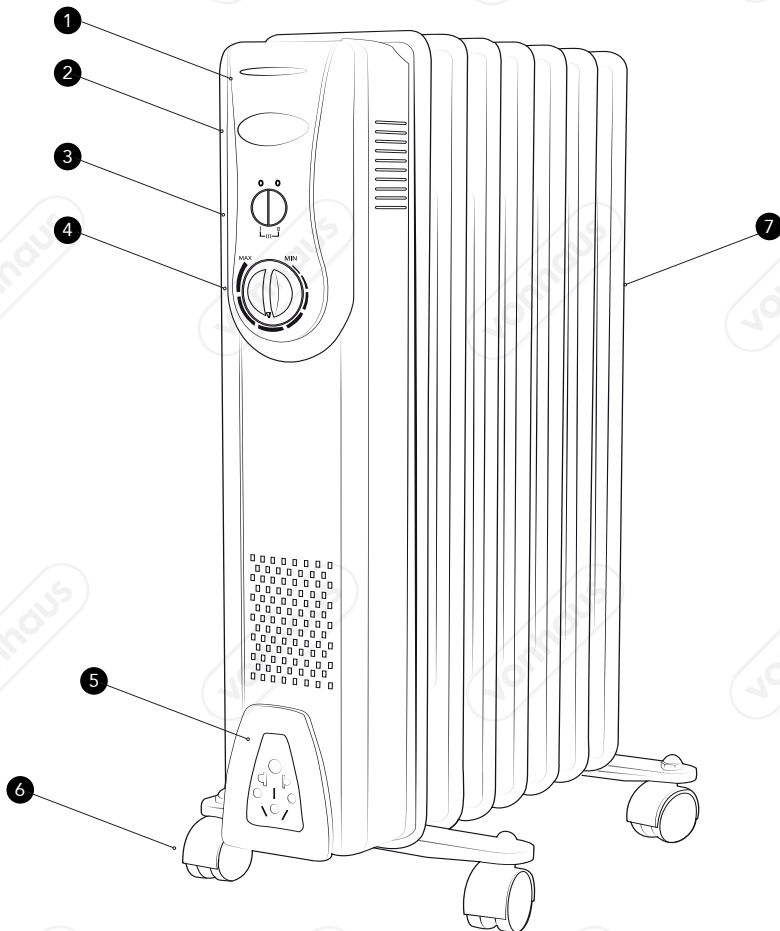

1. Indicator Light
2. Handle
3. Power Selector Switches
4. Thermostat Dial
5. Plug Storage
6. Castor Wheels
7. Radiant Fins

INFORMATION REQUIREMENTS FOR ELECTRIC LOCAL SPACE HEATER

Model	2500108				
Item	Symbol	Value	Unit	Item	Unit
Heat Output				Type of heat input for Electrical Storage Heaters only (select one)	
Nominal Heat Output	P_{nom}	0.7191	kW	Manual heat charge control with integrated thermostat.	no
Minimum Heat Output (indicative)	P_{min}	0	kW	Manual heat charge control with room and/or outdoor temperature feedback.	no
Maximum Continuous Heat Output	P_{max}	0.7191	kW	Electronic heat charge control with room and/or outdoor temperature feedback	no
Auxiliary electricity consumption				Fan assisted heat output	
At nominal heat output	EL_{max}	N/A	kW	Type of heat output/room temperature control (select one)	
At minimum heat output	EL_{min}	N/A	kW	Single stage heat output and no room temperature control	no
In standby mode	EL_{SB}	N/A	kW	Two or more manual stages, no room temperature control	no
				With mechanical thermostat room temperature control	yes
				With electronic room temperature control	no
				Electronic room temperature control plus day timer	no
				Electronic room temperature control plus week timer	no
				Other control options (multiple selections possible)	
				room temperature control with presence detection	no
				room temperature control with open window detection	no
with distance control option	no				
with adaptive start control	no				
with working time limitation	no				
with black bulb sensor	no				
Contact Details	DOMU Brands Ltd, 4th & 5th Floor, The Tower, Deva City Office Park, Salford, M3 7BF				

BASE ASSEMBLY

Place the body of the Radiator upside down on a scratch-free surface, making sure that it is stable and will not fall.

Locate the U-Shaped Bars and remove the Wing Nuts.

Locate the Bars at the front and rear of the Radiant Fins.

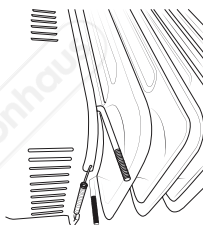

Attach the Wheel Mounting Bracket onto the U-Shaped Bar and secure into place using the previously removed Wing Nuts.

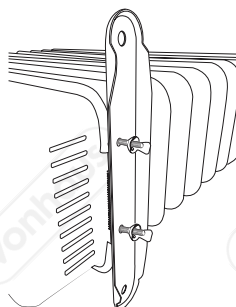

Remove the End Cap Screw from the Wheel, thread the Wheel onto the Wheel Mounting Bracket and secure into place with the End Cap Screw. Ensure everything is tightend and secure before turning upright.

IMPORTANT: After assembly, stand the Radiator upright for **1 hour** before switching on. This will allow the oil to settle into the correct position.

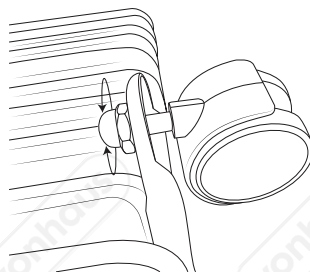

SAFETY FEATURES

This Radiator is fitted with an **overheat protection switch** (thermal cut-out) which will power off the appliance automatically in case of overheating. Should this occur, unplug the appliance and allow to cool fully for approximately 30 minutes.

Follow the operation instructions to restart the appliance after removing the source of the overheating (poor ventilation, item covering the Radiator etc.). The Radiator should function normally. Should the problem persist, please contact DOMU Brands Customer Services.

To avoid damage and to regulate the temperature, this Radiator is fitted with a **thermostatic safety device**. The safety device will activate and cut out the power to the Radiator once a certain temperature is reached. The Radiator will start again once the temperature has lowered.

The Radiator is also fitted with a **tip switch** which will cut off the power to the Radiator if it is knocked over. Should this happen, disconnect at the mains and allow to cool fully before attempting to move the Radiator. Inspect the Radiator for damage. If - and only if - the Radiator is free from damage, plug back into the mains. The Radiator should function normally.

OPERATION

CAUTION: Before using the Radiator, make sure that it is on a flat and stable surface. Damage may occur if it is placed on an incline or decline.

NOTE: When the Heater is switched on you will hear a crackling/popping sound, this is completely normal and not a fault, it is the oil settling.

Set all the controls to the off position and insert the plug into a socket outlet, ensuring the plug fits firmly.

Rotate the Temperature Dial clockwise to the **MAX** position and switch the Radiator on as follows:

Once your room reaches the desired temperature, slowly rotate the Thermostat Knob anticlockwise until the pilot light goes out. It can now be left at this setting. As soon as the room temperature has dropped below the set temperature, the unit will switch itself on automatically until the set temperature has been reached again. In this way, the room temperature remains constant with the most economical use of electricity.

If you want to change the room temperature setting, rotate the Thermostat Knob clockwise to raise the temperature, or anticlockwise to lower it.

This Radiator is fitted with an overheat protection system that shuts off the Radiator should parts of the Radiator become excessively hot.

To completely shut the Radiator off, turn all the controls to the off position and remove plug from the socket outlet.

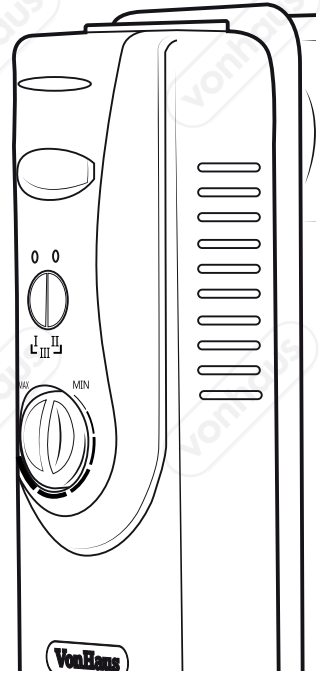

CONTROLS

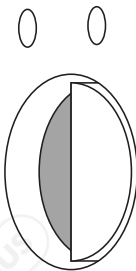

LOW HEAT

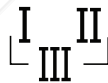
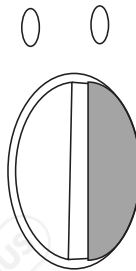

MEDIUM HEAT

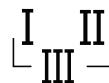
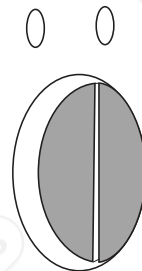

HIGH HEAT

CLEANING & CARE

CAUTION: Switch off the Radiator and disconnect the from the power socket. Wait for the Radiator to cool completely before cleaning.

Vacuum-clean the Vents **(7)** to remove dust from these areas.

To remove dust on external surfaces, wipe the Radiator with a damp (not wet) lint-free cloth rinsed in hot soapy water only.

CAUTION: Do not use any harsh detergent or abrasive cleaners.

WARNING! Do not spray with liquids or submerge in any liquid or water.

WARNING! Do not attempt to clean the inside of the Radiator. Do not attempt to open the casing at any time. There are no user-serviceable parts.

TROUBLESHOOTING

PROBLEM	SOLUTION
THE RADIATOR WILL NOT POWER ON	Ensure the Radiator is switched on and connected to mains power. Activate the Power Selector Switches and Thermostat Knob. Check the fuse by replacement.
THE RADIATOR IS NOT HEATING UP	Check that the Radiator is plugged in and switched on at the mains outlet. Make sure that the Radiator has not gone into overheat protection mode (see ' Safety Features '). The Vents may require need cleaning.
THE RADIATOR BECOMES DAMAGED	Do not use and contact DOMU Brands Customer Services.

If you are having difficulty using your product and require support, please contact **hello@domu.co.uk**

USER NOTES

Vonhaus

Vonhaus

Vonhaus

Vonhaus

Vonhaus

Vonhaus

Vonhaus

Vonhaus

Vonhaus

Vonhaus

Vonhaus

Vonhaus

Vonhaus

Vonhaus

Vonhaus

Vonhaus

DISPOSAL INFORMATION

Please recycle where facilities exist. Check with your local authority for recycling advice.

WARRANTY

To register your product and find out if you qualify for a free extended warranty, go to:

www.VonHaus.com/warranty

Please retain a proof of purchase receipt or statement as proof of the purchase date.

The warranty only applies if the product is used solely in the manner indicated in the Warnings page of this manual, and all other instructions have been followed accurately. Any abuse of the product or the manner in which it is used will invalidate the warranty.

Returned goods will not be accepted unless re-packaged in its original packaging and accompanied by a relevant and completed returns form. This does not affect your statutory rights.

No rights are given under this warranty to a person acquiring the appliance second-hand or for commercial or communal use.

COPYRIGHT

All material in this instruction manual are copyrighted by DOMU Brands Ltd.

Any unauthorised use may violate worldwide copyright, trademark, and other laws.

VonHaus.com

Thank you for purchasing the 1500W 7 Fin Black Oil Filled Radiator.

VonHaus® is a registered trademark of DOMU Brands Ltd
Made in China for DOMU Brands Ltd M24 2RW

VonHaus